

# OVERVIEW CATALOG

INNOVATIVE SAFETY SOLUTIONS



# Catalog contents

<b>Innovative safety solutions</b> .....	<b>4</b>
LED floor marking .....	6
LED technologies.....	6
examples of use.....	8
Smart controlled intersections .....	10
Anti-collision systems.....	14
examples of use.....	16
Signaling barrier .....	22
Smart parabolic mirror.....	23
LED safety handle .....	24
Forklift safety lights .....	25

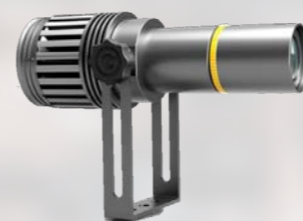

**LED floor marking**  
pages 6 - 11

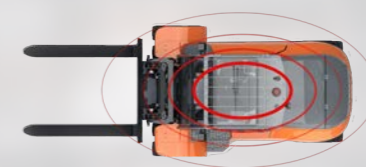

**Anti-collision systems**  
pages 14 - 19

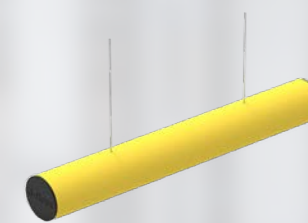

**Signaling barrier**  
page 22

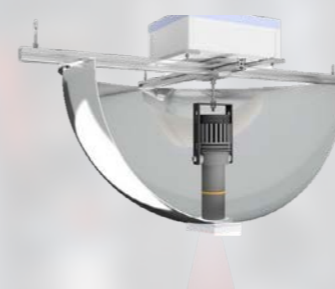

**Smart parabolic mirror**  
page 23



**LED safety handle**  
page 24



**Forklift safety lights**  
page 25



# Innovative safety solutions

## LED floor marking & anti-collision system

marking of the danger zone in the immediate proximity of the crane



# LED floor marking

## LED technologies

Light floor marking with LED technology offers 3 possible types of projection of signs or various symbols on the floor: lighting (24/7), flashing, pulsating. In order to achieve the maximum elimination of operational blindness, LED marking can be activated for pre-defined movement (pedestrians and handling or crane equipment).



activation by movement



flashing or pulsating



non-stop lighting (24/7)



Combined symbol  
Lear Corporation s.r.o.

### Marking of loads carried by cranes

The marking draws attention to the movement of the transported load and visualizes its position. The increased level of safety allows the crane operator to handle the load faster, which leads to an increase in work efficiency and a reduction in human factor errors.



Moving loads  
Franke Slovakia, s.r.o.

### Industrial LED projector

The LED light marking system is based on an industrial LED projector with an active or passive type of cooling. The projectors are dustproof with IP protection 65. Light marking is suitable for all types of industries, from automotive to food or heavy, metallurgical industry.



**industrial design**  
suitable for all industrial environments



**industrial marking**  
wide portfolio of signs and symbols, possibility of own design

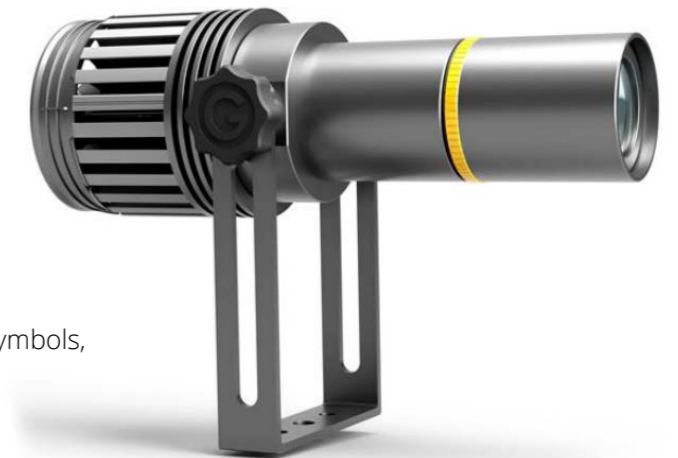



# LED technologies

## examples of use

01

### Moving loads - industrial marking for overhead cranes

The projected sign warns against the movement of the equipment and indicates the position of the hook/load for employees and others in the proximity of the crane. The shape of the safety symbol can be either circular or rectangular - depending on the shape of the load. The projection of the danger zone around the load can be activated for the entire time the crane is activated, or, for example, if the crane is in motion.

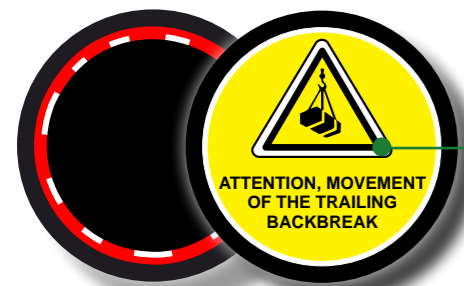

vector design of GOBO glass

02

### Large dimensional symbols - pedestrian crossing

A wide portfolio of signs offers symbols of large dimensions, for example a pedestrian crossing, or symbols composed of several signs in one. The size of the resulting symbol on the floor depends on the installation height of the projector.

For example: 10 m installation height - symbol size (∅) for 1 projector - 600 cm.

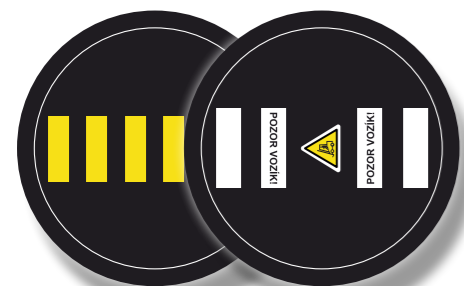

03

### Standard ISO symbols and design to order

It is possible to choose from all kinds of standard ISO symbols and symbols according to customer's own design to order, for example a company logo or a combination of selected standard symbols in one.

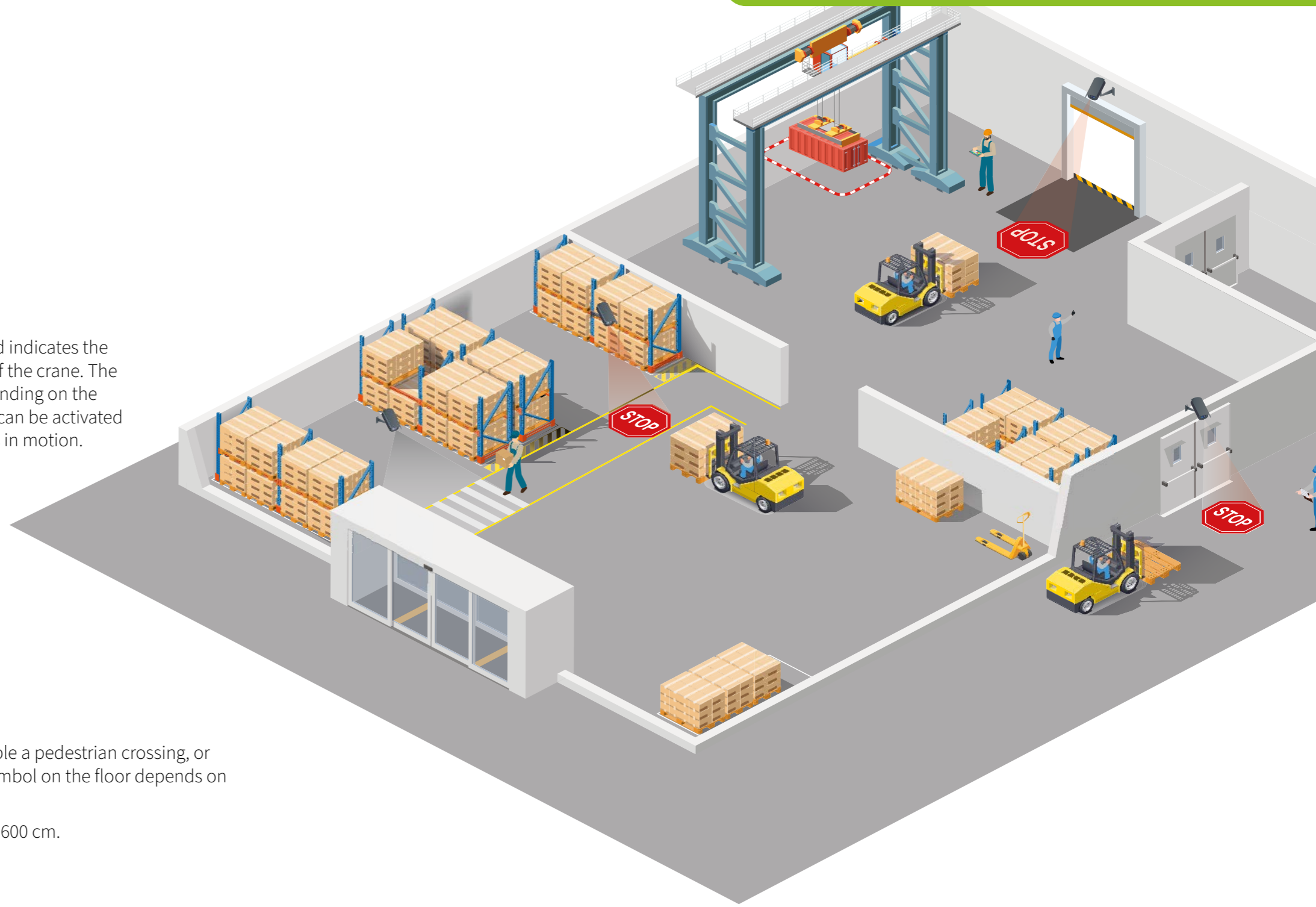

## Frequently used types of symbols



entrance ban



STOP symbol



forklift symbol



multi symbol



# Smart controlled intersections

## dynamic floor marking

Dynamic floor marking increases safety in workplaces with a high frequency of movement of handling equipment. The LED projection of the crossing for pedestrians with a warning symbol is controlled based on the presence of handling equipment in the dangerous zone of the crossing.



**Lear Corporation a.s.**  
Signaling of danger of collision with forklift



**pedestrian crossing**  
visible during safe operation =  
forklift is not in reach



**STOP symbol**  
visible in case of danger of  
collision = forklift in reach



**UWB/senzorics**  
detection of the presence of  
forklift to the intersection

### CHARACTERISTICS OF INTELLIGENTLY CONTROLLED INTERSECTIONS

<b>ROI</b>	return on investment 1.25 years, depending on the frequency of renewal of markings
<b>technologies</b>	intersection control using a motion sensor or through the UWB anti-collision system
<b>interactivity</b>	dynamic switching of symbols depending on the movement of the manipulation technique
<b>to order</b>	choice of symbols and colors according to the customer's individual wishes

## Automatic gate locking

When the handling equipment approaches, the gate automatically locks and prevents pedestrians from colliding with the handling equipment.



**Lear Corporation a.s.**  
signaling of a safe pedestrian crossing







**LED floor marking**

illumination of warning symbol when forklift is approaching



# Anti-collision systems

## forklift vs forklift, forklift vs human

The autonomous anti-collision system prevents work accidents associated with operational blindness, blind spots in operation, movement of forklifts, crane and other handling equipment. The systems eliminate the risk of human error and warn both parties in time of the potential danger of a collision (optically, acoustically, opto-acoustically).

premium distributor



**from fleet to fleet**  
compatible with all manufacturers of handling equipment



**connectable with floor markings**  
activation of LED light marking by movement of handling equipment or a pedestrian

### ANTI-COLLISION SYSTEM FUNCTIONS

<b>forklift-forklift</b>	autonomous deceleration of a forklift against a forklift in two predefined zones
<b>forklift - pedestrian</b>	autonomous forklift deceleration against a pedestrian, interactive warning of the pedestrian by vibrations
<b>deceleration of the forklift in circular zones</b>	autonomous adjustment of the maximum speed of the forklift in critical places (zones), e.g.: slowing down the forklift to a maximum of 4 km/h
<b>deceleration of the forklift according to the direction of a ride</b>	autonomous adjustment of the maximum forklift speed when entering halls and separate areas, e.g.: maximum forklift speed 6 km/h in the entire production hall (the system is deactivated when exiting)
<b>forklift - LED floor marking</b>	intelligent control of the LED floor marking according to the presence of a forklift in the proximity

#### Diagnostic station

Diagnostic station for immediate checkout of the battery status and the functionality of the personal tag.

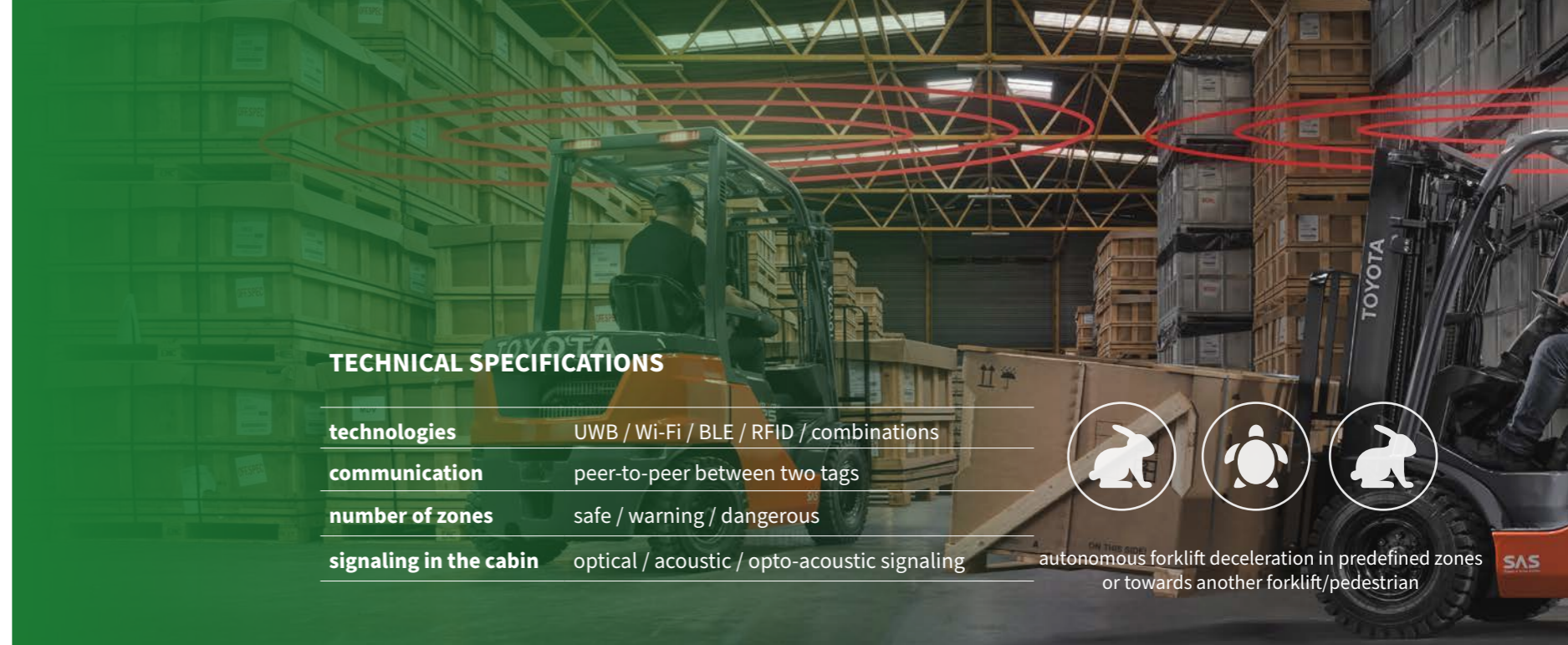

### TECHNICAL SPECIFICATIONS

<b>technologies</b>	UWB / Wi-Fi / BLE / RFID / combinations
<b>communication</b>	peer-to-peer between two tags
<b>number of zones</b>	safe / warning / dangerous
<b>signaling in the cabin</b>	optical / acoustic / opto-acoustic signaling



autonomous forklift deceleration in predefined zones or towards another forklift/pedestrian

## Two-phase deceleration of handling technique

Direct communication (peer-to-peer) between the tags installed on handling equipment and the tags equipped with pedestrians ensures the protection of forklifts and employees from accidents caused by lack of visibility and inattention in blind spots of operation. Wireless communication triggers predefined actions, which can be: slowing down the forklift, starting or switching the LED light marking, vibrating the personal tag, light signaling of danger in the forklift driver's cabin and others.

#### immunity RGB button



#### opto-acoustic RGB beacon

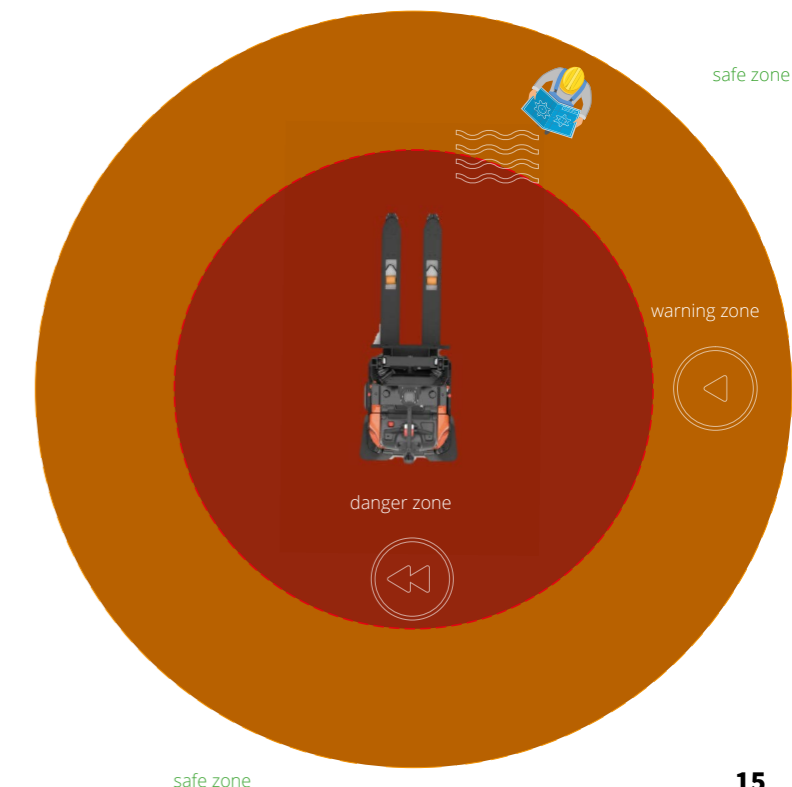



# Anti-collision systems

## examples of use

01

### Forklift anti-collision system

Autonomous slowing down of the handling technique to the minimum possible speed. It is warning the drivers in the cabin using opto-acoustic signaling.



portable from fleet to fleet



autonomous forklift slowing down

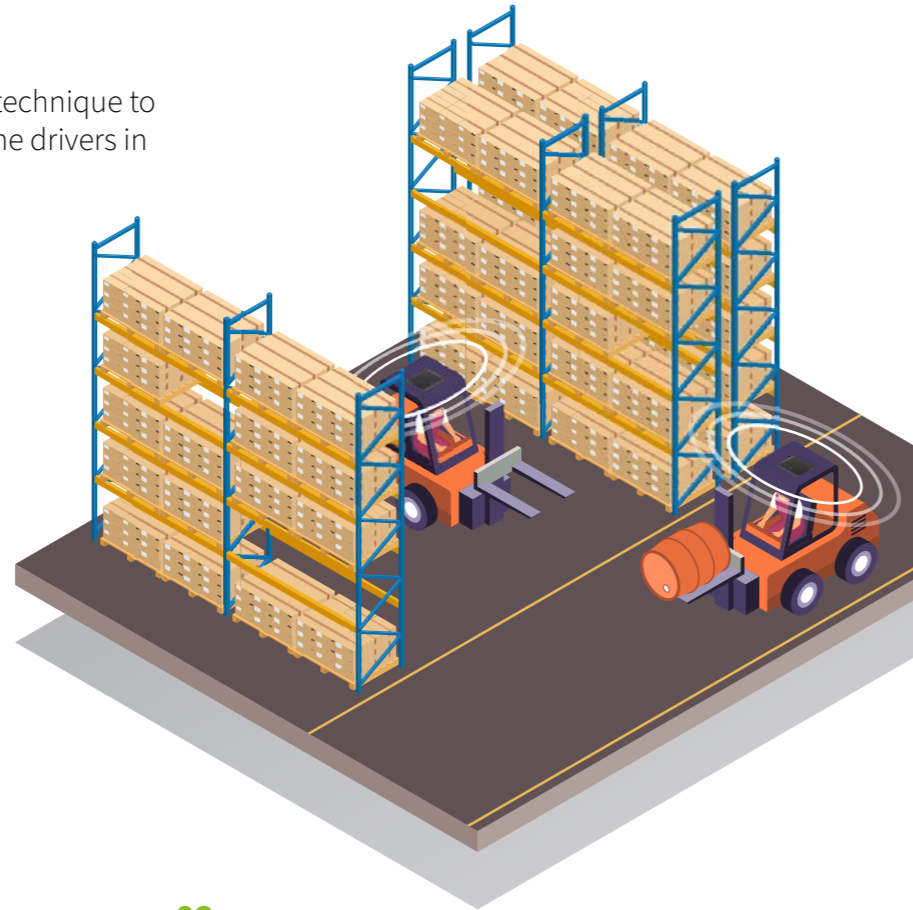

02

### System against collision with pedestrians

Autonomous reduction of the speed of handling equipment in the dangerous proximity of pedestrians. Active warning to driver about pedestrians using a personal tag using opto-acoustic signaling inside the cabin.



interactive protection for pedestrians



elimination of operational blindness

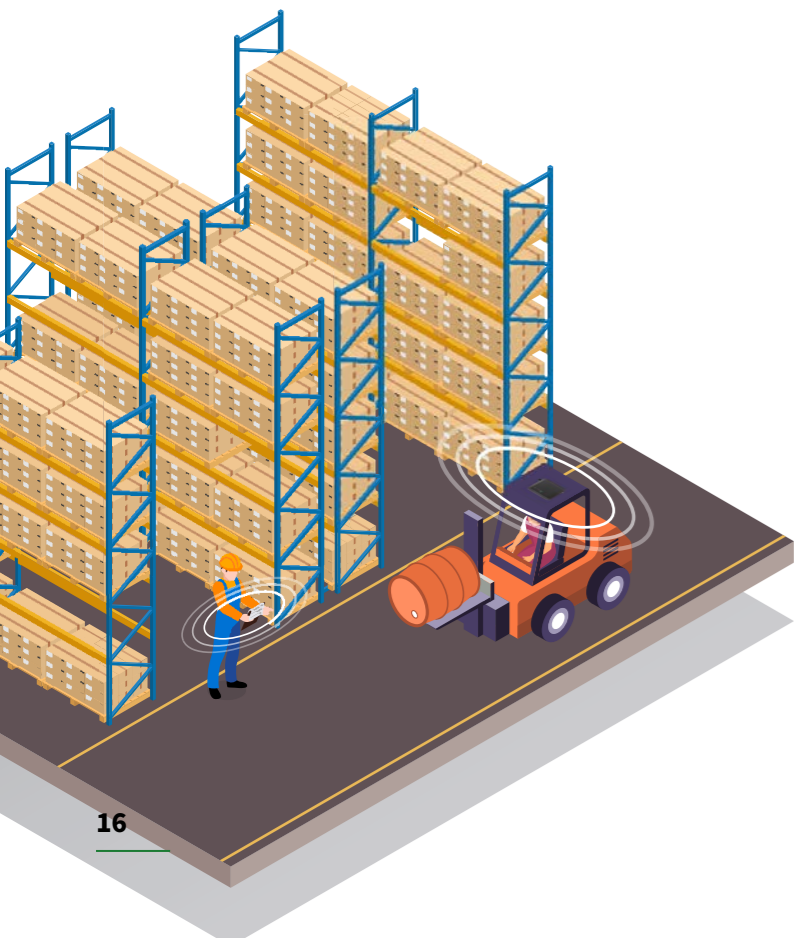

03

### Smart management of floor markings

Projection of safety floor markings switched on by forklift movement. Peer-to-peer communication between the forklift tag and the reading device connected to the LED projector.



elimination of operational blindness



risk reduction of near misses

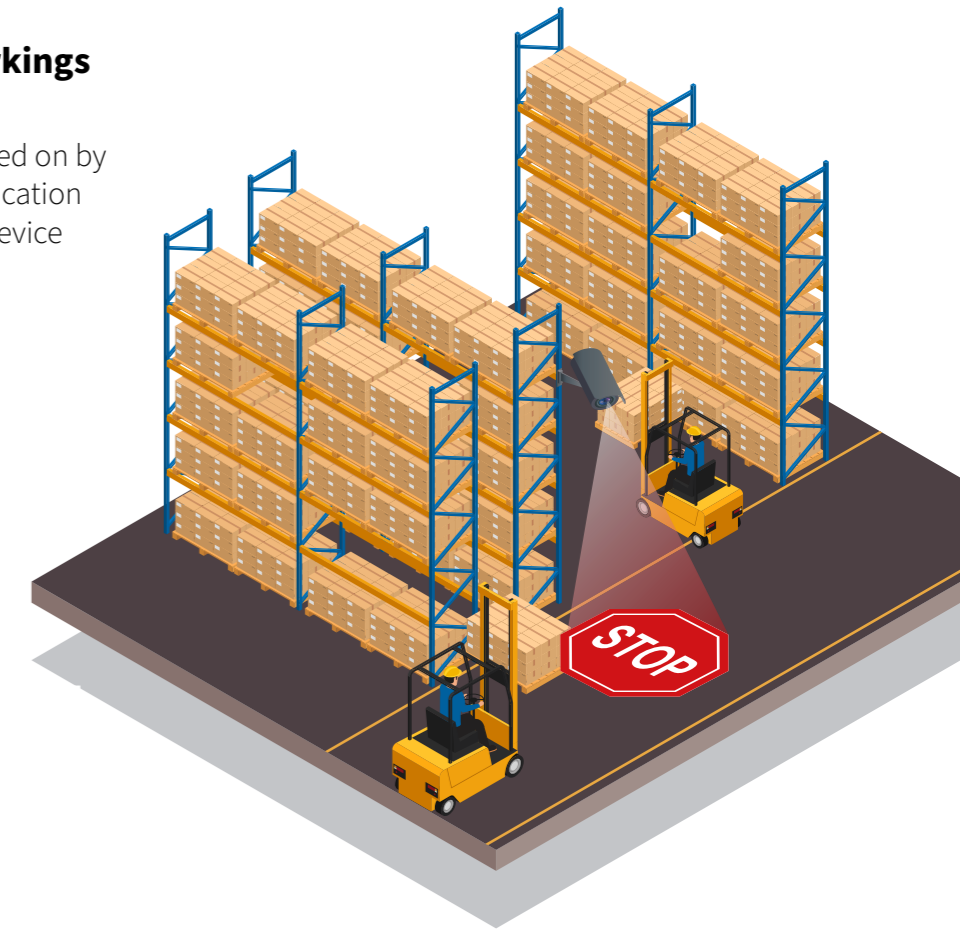

04

### Deceleration of forklifts in zones

Autonomous deceleration in the zone according to the direction of the forklift to a predetermined maximum speed. Often used to slow down within selected sections and dangerous sections.



deceleration of the forklift to maximum predefined speed



possible detection of ride direction

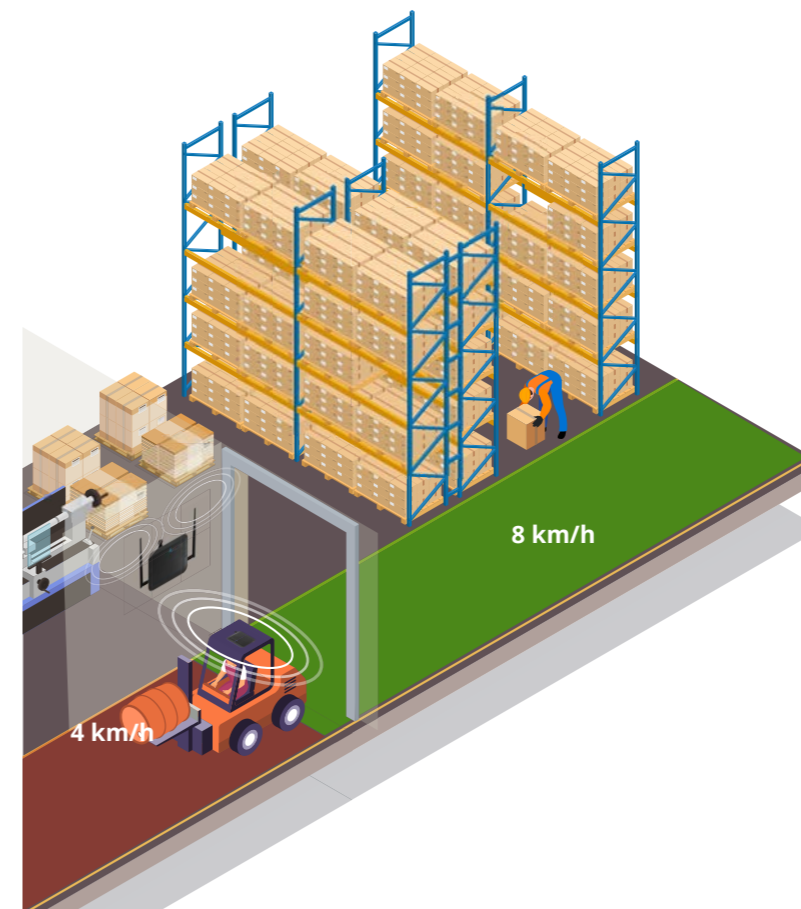



# Anti-collision systems

## examples of use

05

### Forklift anti-collision system

Autonomous deceleration to the required speed when entering the critical zone followed by acceleration to the original speed when exiting.



pre-setting of speed in dangerous zone



reduction of near misses

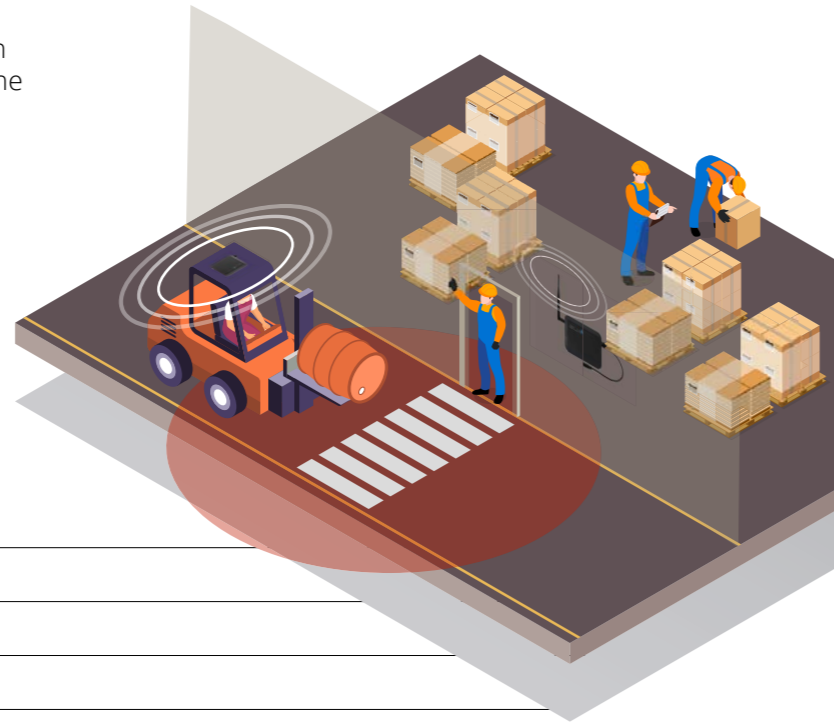

#### CHARACTERISTICS OF ZONAL DECELERATION

<b>zone quantity</b>	1 reading device = 1 zone
<b>technology</b>	UWB wireless technology
<b>forklift speed</b>	according to customer's needs
<b>zone size</b>	up to 20 m / 1 reading device
<b>examples of use</b>	at the entrance of pedestrians to the road, near toilets and offices, at risky places, in entire production halls
<b>extension</b>	connection to LED projection (e.g. smart controlled intersections)

#### Mobile and web application

Mobile and web application for easy and immediate changes in anti-collision system parameters.

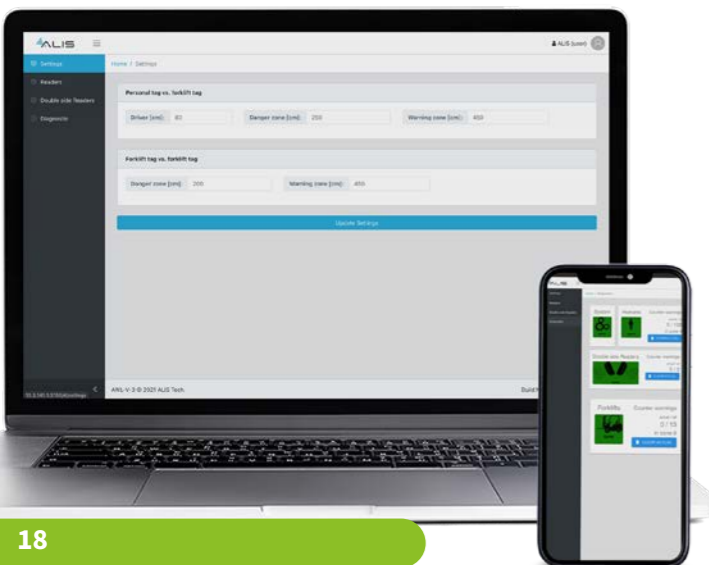

06

### Rack anti-collision system

Collision warning system designed to reduce or eliminate accidents at blind corner intersections and in racks. The device is equipped with two forms of alarm – a visual one (a bright flashing red light) and sound (a loud audio warning).



elimination of operational blindness



risk reduction of near misses

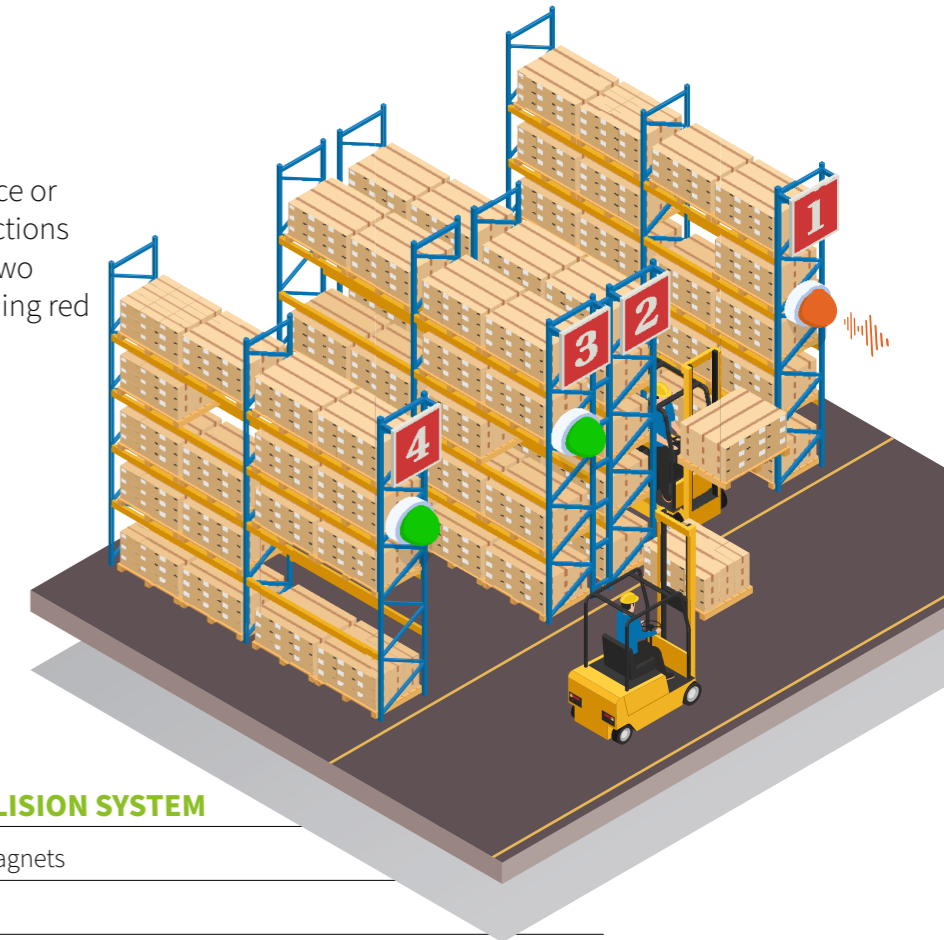

#### CHARACTERISTICS OF RACK ANTI-COLLISION SYSTEM

<b>installation on racks</b>	mounted with strong magnets
<b>danger signaling</b>	visual and sound alert
<b>power</b>	self-powered (standard D-cell batteries)
<b>size of zone detection</b>	7,62 meters
<b>number of zones</b>	2 detection zones

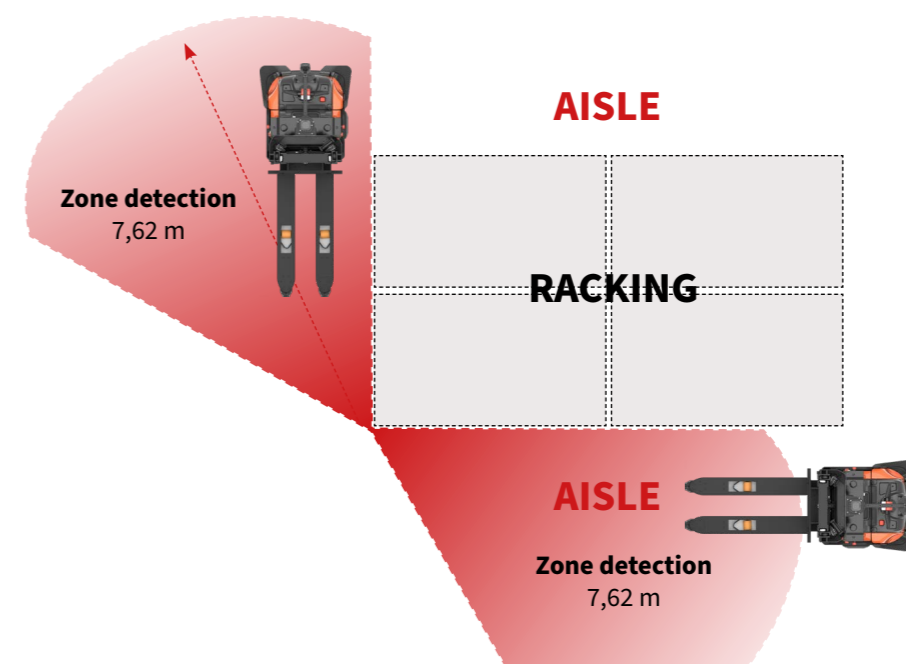





**Protection of pedestrians and visitors in operation**  
Signaling the danger of a collision with a forklift

1. on-site visit

2. solution suggestion

3. production of a custom-made system

4. installation

5. service maintenance

customized solutions





signaling barrier  
tested in Maier CZ s.r.o.

# Signaling barrier

## Interactive safety elements

Ensuring safe passage under lowered profiles without accidents caused by excessively raised loads. The system is equipped with an intelligent touch sensor, which triggers a high-frequency sound alarm and flashes LED signaling lights in the event of an impact.

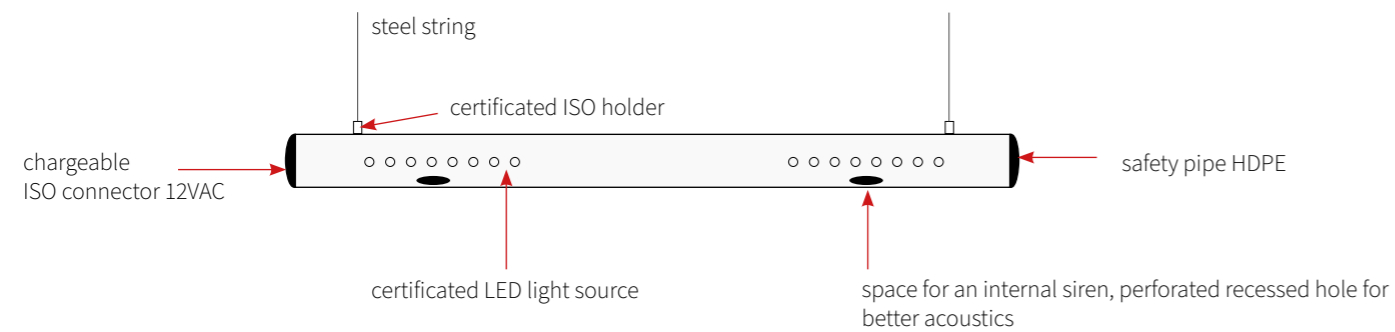

### TECHNICAL SPECIFICATION

<b>Dimensions</b>	1 800 x 140 [mm]	<b>Luminous intensity</b>	79lm/M
<b>Power type-standard</b>	12 VDC - 230V AC	<b>Color</b>	RAL 1021
<b>Siren duration</b>	7 seconds	<b>False alarm detection</b>	smart impact sensor false alarm proof (e.g. wind)
<b>Siren volume</b>	102 dB	<b>IP code</b>	IP 20 standard IP 44 possible

# Smart parabolic mirror

## interactive OHS elements

Smart parabolic mirror with built-in intelligent LED light marking system.



### TECHNICAL SPECIFICATION

<b>mirror size</b>	Ø 100 [cm] standard / Ø 80 [cm]
<b>material</b>	acrylate, polyacrylate
<b>characteristics</b>	pedestrian detection vs. forklift; distinguish ride direction; activation of LED floor markings (range up to 12 m)
<b>signalization</b>	light signaling of the ride direction
<b>LED lights</b>	pulsating / flashing / 24/7 lighting; activation of LED projector when the forklift approaches the cross road



signaling the direction of arrival of the forklift to the parabolic mirror

detection of the direction of arrival of the forklift to the parabolic mirror



smart parabolic mirror  
Continental Barum a.s.

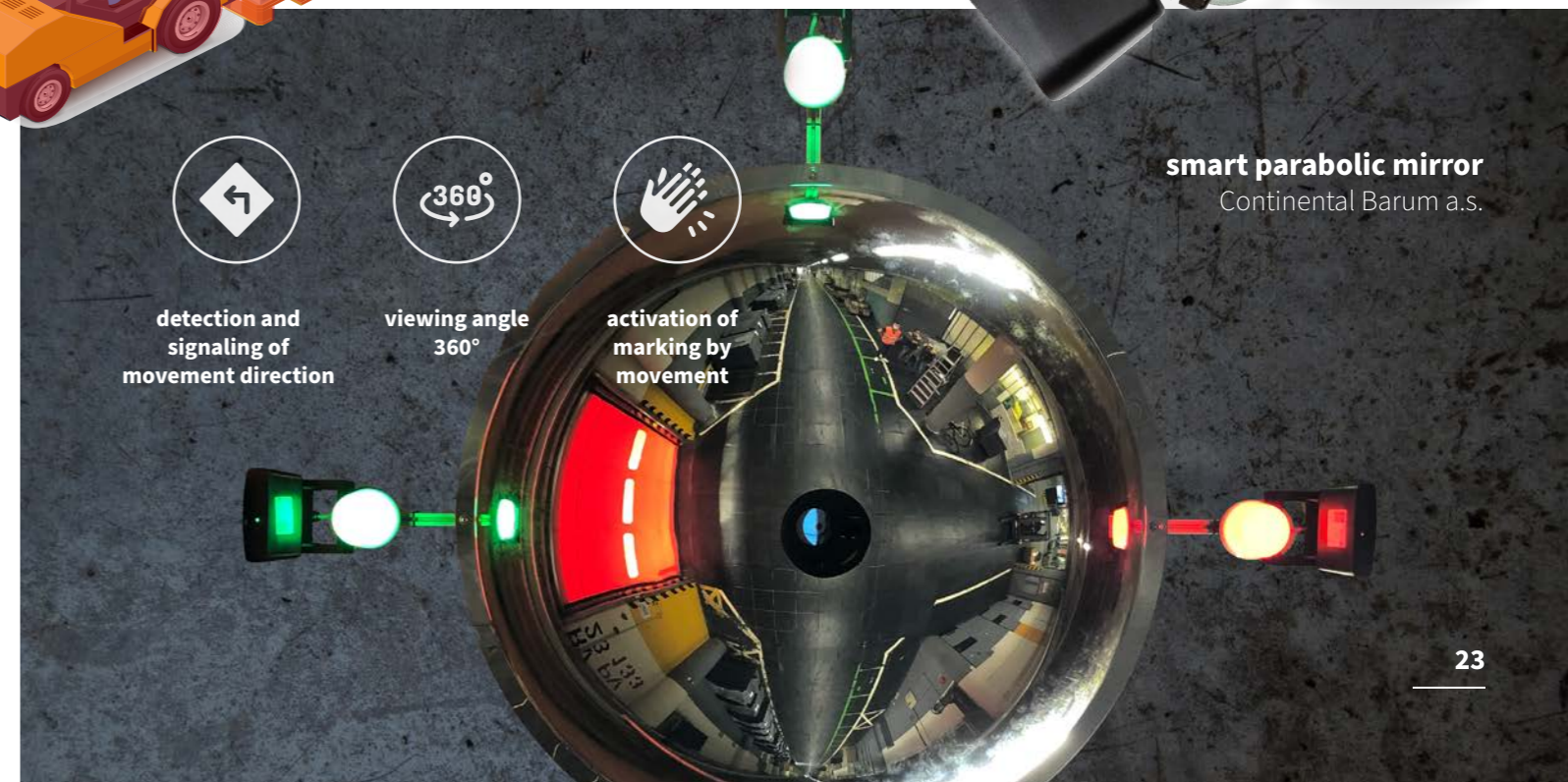



## TECHNICAL SPECIFICATION

<b>Lifetime</b>	up to 200 000 cycles
<b>Power</b>	battery AA (3.6V / 2 500 mAh)
<b>Variants</b>	handle-handle, handle-knob
<b>Cerification</b>	EN 196/2010
<b>Fire resistance</b>	B
<b>Material</b>	stainless steel



# Forklift safety lights

## protection when forklift moving

The light zone effectively signals to pedestrians a safe distance from the work space of the forklift truck. LED technology or laser light displays a red or green line on the floor and thus creates a „safe“ zone around the forklifts.

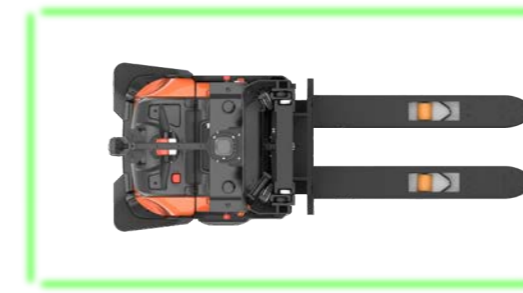

line -line

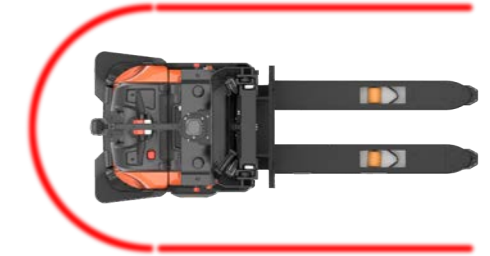

semicircle + line

# LED safety handle

## interactive safety solutions



**durable shield forging**  
knob handle - handle shape L



**shield forging**  
knob handle - handle shape J



**durable shield forging**  
handle shape L - handle shape L



**durable rosette forging**  
handle shape L - knob handle



**durable forging**  
handle shape L - handle shape L



**rosette forging**  
knob handle - handle shape J



**LINE**  
with adjustable length



**LINE**  
side installation to a forklift



**SEMICIRCLE**  
back installation to a forklift





# ALEDO S.R.O.

experts for innovative safety

Aledo has been operating on the European market since 2011. Our mission is to protect human lives and handling equipment in the busy working environment of medium and large enterprises.

We transform dangerous places in operation into safe workplaces without serious accidents and near misses, with the help of autonomous systems built on the latest technologies on the market.

Among our satisfied customers, we count a large manufacturing company from the automotive and food industries and the logistics sector.



**800+**

REALIZED  
PROJECTS

**400+**

SATISFIED  
CUSTOMERS

[www.aledo.sk](http://www.aledo.sk)

aledo@aledo.sk | +421 902 189 277  
Za plavárňou 8907/15, Žilina 010 08, Slovakia

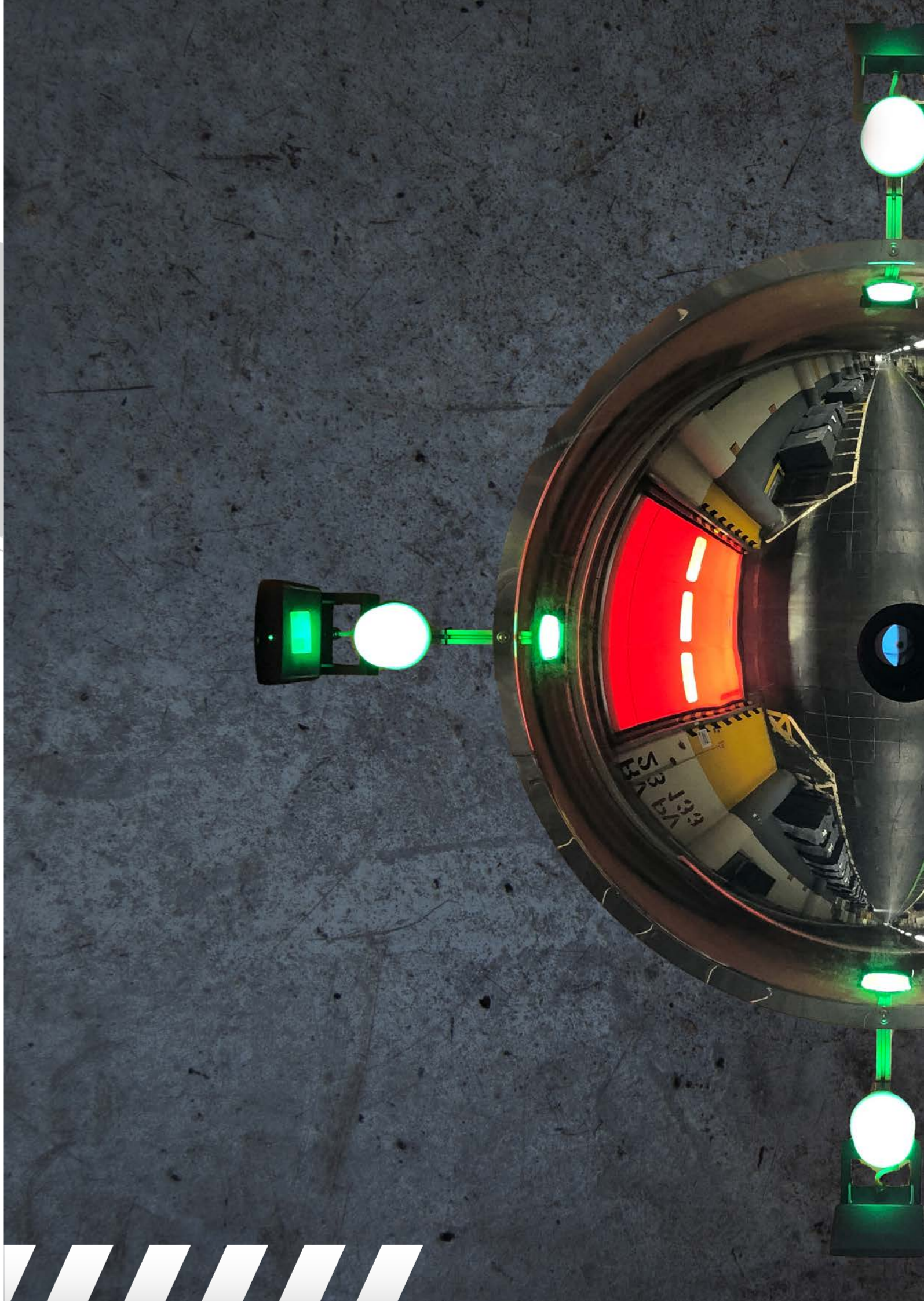



your distributor



[www.aledo.sk](http://www.aledo.sk)

[aledo@aledo.sk](mailto:aledo@aledo.sk) | +421 902 189 277